



**GRANAT
BIO TECH**

Granat Bio Tech LLC

10 Akademika Kadyshevskogo Street,
Dubna, Moscow Region, Russia, 141980

Tel.: +7 (495) 103-41-16

e-mail: info@granatbio.ru

www.granatbio.ru

APPROVED BY

Director General
Granat Bio Tech LLC

A.L. Shishov

17th January, 2022



Medical Product User Manual

**Acti-Fine[®] Vacuum Venous Blood Collection Tubes with
and without additives**

Type:

**Acti-Fine[®] Vacuum Venous Blood Collection Tubes with
Lithium Heparin, Gel**

CE



1. Name of medical product

Medical devices family:

Acti-Fine® Vacuum Venous Blood Collection Tubes with and without additives as per TC 32.50.50-001-00057974-2017, versions:

Medical device

Acti-Fine® Vacuum Venous Blood Collection Tubes with Lithium Heparin, Gel.

2. Data on the manufacturer of medical product

Manufacturer/Developer:

Granat Bio Tech Limited liability company
Granat Bio Tech LLC
10 Akademika Kadyshevskogo Street, Dubna,
Moscow Region, Russian Federation, 141980
Tel.: +7(495) 103-41-16

Address of medical product manufacturing:

Granat Bio Tech LLC
10 Akademika Kadyshevskogo Street, Dubna,
Moscow Region, Russian Federation, 141980

Authorized EU representative:

M. Schilling GmbH
Medical Products
In den Kappeswiesen 18
63571 Gelnhausen
Germany

3. Designation of medical product as determined by the manufacturer

Acti-Fine® Vacuum Venous Blood Collection Tubes with Lithium Heparin, Gel (hereinafter referred to as the Vacuum tubes) are designed for collection, storage and transportation of venous blood for different types of clinical and laboratory studies. It is *in vitro* diagnostic medical device.

Area of application

Clinical diagnostic laboratories, blood transfusion centers, health care centers and blood collecting points.

Potential consumer/Conditions of use



The Vacuum tubes are intended to be used by specialists of medical institutions, health care centers, or blood transfusion centers, having a due diploma certifying completion of secondary vocational medical education institution, and having venipuncture skills, including laboratory employees.

The Vacuum tubes are used for patients irrespective of their age, sex, ethnic origin or other human characteristics.

Type of contact with human body

The Vacuum tubes have short-term (less than 24 h) indirect contact.

Intended use

The Vacuum tubes are an auxiliary aid in diagnostics and are used in obtaining data for diagnostics of diseases, physiological or pathological state of a person.

Contraindications

No

Possible side effects

When properly stored, transported or used according to the operating documentation – there are no side effects.

4. Principle of operation

The principle of operation is based on the use of a tightly closed and sealed tube with pre-defined vacuum. The patient's vein is punctured with the long end of a double-ended needle for blood collection (available separately) inserted into the holder. The rubber stopper of the Vacuum tube is pierced with the short end of the needle. The Tube is filled with the pre-defined blood volume under vacuum.

5. Description of medical device

The Vacuum tubes are tubes of polyethylene terephthalate (PET) with pre-defined vacuum for collection of an accurate volume of blood. The Vacuum tubes are closed with safety screw caps designed to prevent staff contact with potentially hazardous biological medium. To remove a cap from a Vacuum tube, turn it counterclockwise. It is impossible to remove a cap just by pulling it up.

The Vacuum tubes meet the requirements and recommendations of EN ISO 6710:2017 Single-use containers for venous blood specimen collection. Selection of the tube type depends on the test method, test systems and/or equipment, which the tests are carried out on.

The Vacuum tubes are sterile single-use medical products supplied in a sterile state. All the parts of the Vacuum tubes are for single use only and may not be used repeatedly.

The Vacuum tubes are made of different standard sizes, with different additives and for collection of different volumes of blood.

a) different standard sizes of tubes (diameter x height, mm):

- 13 x 75;
- 13 x 100;
- 16 x 100.

b) different additives:

- Lithium heparin, gel

c) different volume of blood collection:

from 1.0 ml to 9.5 ml.

Each Vacuum Tube includes:

1. Tube;
2. Stopper;
3. Cap;
4. Additive (if applicable).

The Vacuum tubes structure is shown in Fig. 1.

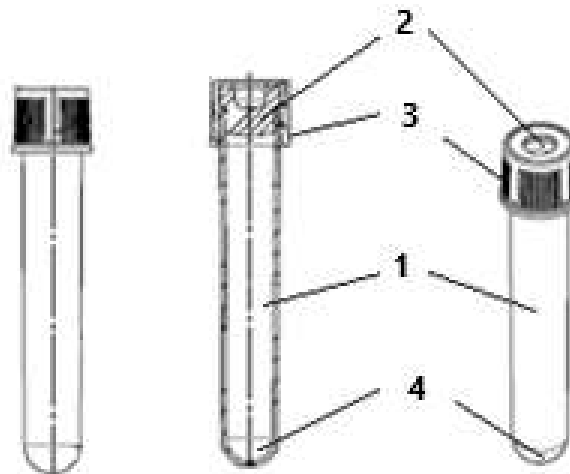

- 1- tube;
- 2 – stopper;
- 3 - cap;
- 4 - additive.

Fig. 1

Notes: 1. The product does not contain any medication or pharmaceutical substance.

Dimensions of Vacuum tubes depending on the variant:

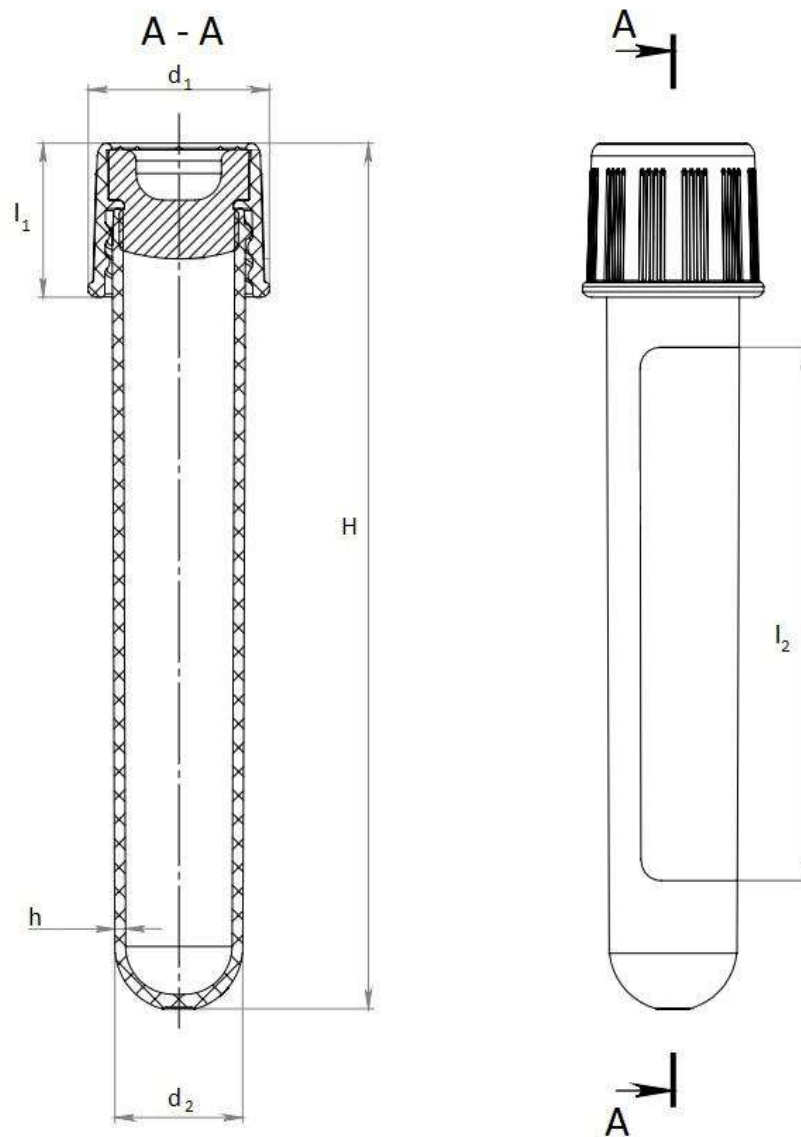

Drawing 1.

Standard size	Dimensions, mm						Weight complete tubes (without additive and labels), g
	d1	d2	l1	l2	H	h	
13 × 75	17.00±0.3	12.00±0.2	14.45±0.2	50.00±0.3	81.15±0.5	1.00±0.25	5.6 (±0.7)
13 × 100	17.00±0.3	12.00±0.2	14.45±0.2	50.00±0.3	106.15±0.6	1.12±0.30	7.1 (±0.8)
16 × 100	18.00±0.3	14.32±0.3	15.09±0.3	50.00±0.3	106.09±0.7	1.07±0.15	8.6 (±0.9)

Vacuum venous blood collection tubes with lithium heparin, gel is used to study plasma or whole blood in a clinical laboratory, for biochemical analyzes, immunology (vitamins, hormones, immune status) and express diagnostics. Can be used to study the blood of patients receiving anticoagulant therapy.

The range of offered Vacuum venous blood collection tubes with lithium heparin, gel is presented in table 1

Table 1

Catalogue number*	Volume of sample taken, ml	Color of cap	Dimensions, m
10041000	1,0	Green	13×75
10041500	1,5		
10042000	2,0		
10042500	2,5		
10043000	3,0		
10043500	3,5		
10044000	4,0		
11044000	4,0	Green	13×100
11044500	4,5		
11045000	5,0		
11045500	5,5		
11046000	6,0		
12046000	6,0	Green	16×100
12046500	6,5		
12047000	7,0		
12047500	7,5		
12048000	8,0		
12048500	8,5		
12049000	9,0		
12049500	9,5		

Note: *last two digits of catalogue number can be changed depending on type of design and the label used:
 - penultimate digit: 0 - 50 pieces in a pack, 1 - 100 pieces in a pack;
 - the last digit: 0 - normal; 1 - pre-barcoded; 2 - tear-off barcode; 3 - digital code; 4 - tear-off digital code; A, B, ..., Y, Z - for an individual customer order (the number corresponds to the customer's internal code)..

Recommendation for use of Vacuum tubes

Number of stirrings	Minimum coagulation time	Centrifugation conditions	Maximum time before analysis
8 – 10	-	2500 – 3000 g 10 min, 25 °C	2 hours before centrifugation 48 hours after centrifugation

6. Instructions for use

A Vacuum tube is used together with a double-ended needle or a winged needle and a holder (outside the scope of supply; available separately from the Vacuum tube) (Fig. 2), assembled with a needle – (Fig. 3), and a tourniquet – (Fig. 4).

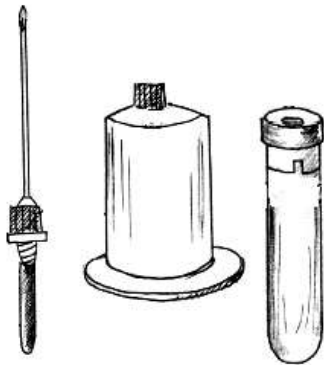

Fig. 2

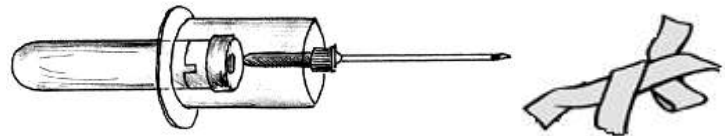

Fig. 3

Fig. 4

Recommendations for the use of needles:

1. Requirements apply to all standard sizes of produced test tubes, regardless of the volume and additives used;
2. Requirements apply only to the back of the needle, which pierces the stopper;
3. The needles must have a gauge G18 - G22;
4. Requirements for the sharpening angle are not imposed (can be used with triangular, spear, flat and other types of sharpening);
5. The length of the needle from the flange to the point must be at least 22 mm.

Before use, factors influencing further research results (interfering substances or limitations associated with the sample that may affect the test result) must be taken into account. If vacuum tubes were transported or stored at a temperature outside the operating temperature range, then before use they must be kept at room temperature for 2 hours.

Description of blood collection (venipuncture) procedure

Use of medical device



Warning!

Wear special gloves during the venipuncture procedure and handling the blood collection tubes to reduce the risk of contamination.

Getting ready and venous blood collection procedure

Before the venipuncture procedure, make sure the following items required for blood collection are available within easy reach:

- Vacuum tubes, double-ended needles (or equivalent) and holders (needle holders);
- everything necessary for personal protection, including gloves and gowns;
- gauze compresses or wipes soaked in alcohol for cleaning of the venipuncture site;

- a tourniquet;
- a dry sterile piece of cotton wool, antiseptic band-aid or bandage;
- a waste bin or its equivalent.

Description of blood collection (venipuncture) procedure

- 1 Take an appropriate tube or tubes.

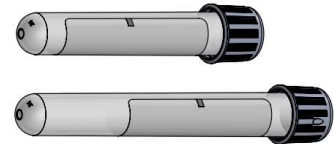

- 2 Remove the cap from the valve part of the double-ended needle.



- 3 Screw the double-ended needle into the holder. Make sure the needle is fixed tightly in the holder and will not screw out during venipuncture.

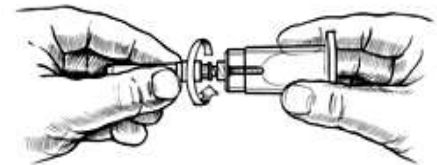

- 4 Select the site for venipuncture.

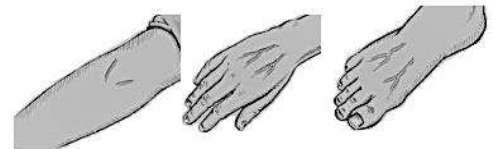

- 5 Apply the tourniquet (max. for 1 minute).
Disinfect the venipuncture site with appropriate disinfectant. **DO NOT TOUCH THE VENIPUNCTURE SITE AFTER DISINFECTION!**

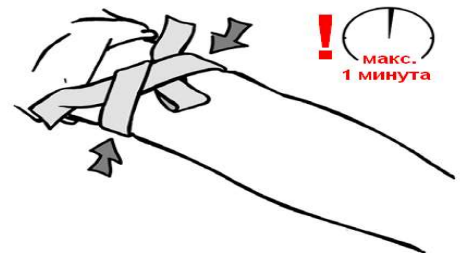

- 6 Remove the other part of the cap from the blood collection needle. Perform venipuncture.

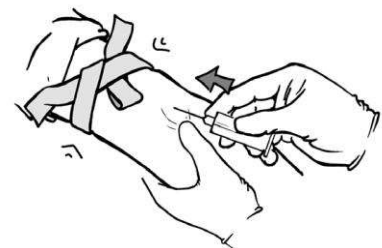

- 7 Insert the Tube into the holder and press so that the needle closed with a valve pierce the rubber membrane in the cap. Place Tubes in the middle of the holder when piercing the cap to avoid piercing of its side wall and early vacuum loss.

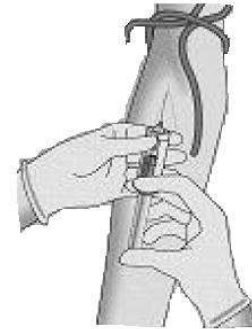

- 8 REMOVE THE TOURNIQUET AS SOON AS BLOOD STARTS FILLING THE TUBE. DURING THE PROCEDURE AVOID CONTACT BETWEEN THE TUBE CONTENTS AND THE CAP OR END OF THE DOUBLE-ENDED NEEDLE. Always hold the Tube in the holder by pressing to its bottom with your thumb to ensure correct filling of the Tube.



- 9 When the first Tube is full and the blood stops flowing into it, remove it from the holder carefully. Immediately after taking a sample mix the Tube with material gently by inverting, it a required number of times. Mix gently to avoid hemolysis. **DO NOT shake the Tube!!!**

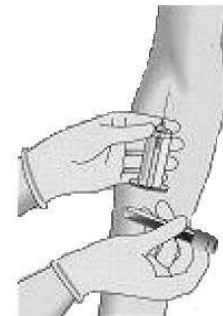

- 10 Place the next Tube into the holder piercing the cap membrane. Make sure the blood starts filling the Tube. Follow the recommendations on blood collection procedure (according to GOST R 53079.4-2008).

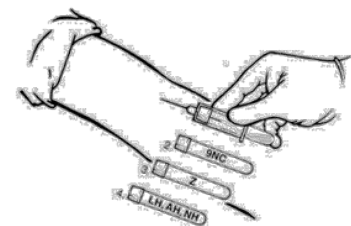

- 11 As soon as the blood fills the last Tube, remove the double-ended needle from the vein carefully, at the same time pressing a dry sterile piece of cotton wool to the venipuncture site until it stops bleeding. After clotting apply bandage or antiseptic band-aid to the venipuncture site.



- 12 Put the used needles and holders to special bins.



Do not shake Tubes.

! Vigorous mixing may cause foaming or hemolysis. Insufficient or slow mixing in serum Tubes may delay clotting. Incorrect mixing in Tubes with anticoagulants may result in platelet clumping, clotting and/or unreliable test result.

! ***Attention!***

! There is a sample filling line on each Tube label, which shows the acceptable ($\pm 10\%$) Tube filling with the patient's biomaterial.



If the blood does not flow into the Tube, or it stops flowing before the Tube is filled up to the filling line on the label, take the following steps to complete blood collection correctly:

- A) Put strong pressure to the Tube bottom to fully pierce the rubber part of the cap. Hold the tube pressing on its bottom with your thumb until the Tube is filled.
- B) Make sure the needle is in the vein.
- C) If the blood still does not flow into the Tube, replace it with a new one.
- D) If the blood does not flow into the second Tube either, remove the needle and put it into a special bin. Repeat the venipuncture procedure from the beginning.



After venipuncture the upper part of the cap may have blood traces. Take safety measures to avoid contact with this blood while handling the Tubes. Any holder contaminated with blood is hazardous and must be disposed of immediately.

Repeated putting of a cap on the needle increases the risk of staff injury with a potentially infected needle.

Placing cap back on the needle increases the risk of infection of personnel with possibly infected needle.

Prevention of blood backflow

It is very important to prevent backflow of blood from the Tube to avoid adverse patient reactions. To prevent blood flow from the Tube back to the patient's vein, observe the following precautions:

- lower the patient's hand a little bit down;
- hold the Tube with the cap up;
- remove the tourniquet as soon as blood starts filling the Tube;
- make sure the Tube contents do not come in contact with the cap or the needle end during the venipuncture.

Common mistakes when handling Vacuum tubes

Why blood does not flow into the Tube with additives and how to solve the problem



Possible cause	Problem solving
The needle end is pressed against the vein wall	Turn the needle carefully without removing it from the vein
The needle has gone all the way through the vein	Pull the needle carefully together with the needle holder without removing it from the vein
The needle has not punctured the vein completely	Press on the needle with the needle holder carefully without removing it from the vein
The tourniquet is too tight or much above the puncture site	Remove the tourniquet
The Tube has already been used or has been open, or the Tube's stopper has been pierced before the needle enters the vein	Replace the Tube

Why blood stops flowing into the Tube with additives and how to solve the problem

Possible cause	Problem solving
The Tube was taken off the needle and removed from the holder too quickly	Insert the Tube into the needle again and leave until the vacuum in the Tube is compensated completely (when the Tube is full, the blood stops flowing)
Blood flows to the Tube too fast (vein is collapsed)	Remove the Tube from the holder for a second, then insert it back again
The needle has damaged the vein during venipuncture or has gone all the way through the vein	Repeat venipuncture at another site where there is no hematoma

Causes of blood hemolysis in the Tube and problem solving

Possible cause	Problem solving
The vein is over compressed (over 1 min.)	Control the time of tourniquet application (max. 1 min.)
The blood is transferred into the Tube with a syringe	Use special double-ended needles for Vacuum Tubes or equivalents that allow blood collection without opening the Tube
The sample has been mixed too vigorously	Invert the Tube gently several times according to cl. 2.3
The Tube is filled incorrectly	Make sure the Tube is filled up to the mark ($\pm 10\%$)

Centrifugation

An important phase of sample treatment to separate the liquid medium from cells. Mistakes during centrifugation may lead to adverse effects;

	In vitro Medical Device User Manual. Acti-Fine® Vacuum Venous Blood Collection Tubes with and without additives Type: Acti-Fine® Vacuum Venous Blood Collection Tubes with Lithium Heparin, Gel		
	Version 2	Review date: 2022-01-17	Page 12

- incomplete sedimentation of cells will reduce the volume of serum or plasma required for testing;
- in case of too many rotations cells may be damaged which will impact the test results.
- Make sure the Tube cap is not leaning against the walls of the centrifuge, otherwise the cap may open during centrifugation.

When choosing the optimum centrifugation conditions, mind the centrifugal force (g), but not the rotor speed (rotations per minute).

A table showing the relation between the number of rotations and the centrifugal force must be attached to the centrifuge datasheet.

7. Data on medical products intended for use in combination with Vacuum tubes

The following medical products approved in the territory of the Russian Federation according to their Registration Certificates are compatible with Vacuum tubes:

No.	Manufacturer	Country of origin	Holder	Double-ended needle	Winged needle
1.	Greiner Bio-One GmbH	Austria	+	+	+
			+	-	-
2.	Guangzhou Improve Medical Instruments Co Ltd	China	+	-	-
			-	+	+
3.	Chengdu Puth Medical Plastics Packaging Co Ltd	China	+	+	+
4.	Becton Dickinson Becton Dickinson Vacutainer Systems Prenalytical Solutions	Great Britain	+	+	+
5.	Granat Bio Tech LLC	Russia	+	+	+

8. Technical specification of medical product

Vacuum Tubes must comply with the dimensions and weight shown in Table 2.

Table 2

Name	Unit of measurement	Rated value
1) Standard sizes of tube (diameter×height)	mm	13×75*
		13×100*
		16×100*
2) Cap dimensions (diameter×height)	mm	17.00×14.45*
		17.00×14.45*
		18.00×15.09*
3) Stopper dimensions (diameter×height)	mm	13.60×10.50*
		13.60×10.50*
		16.00×10.50*

	In vitro Medical Device User Manual. Acti-Fine® Vacuum Venous Blood Collection Tubes with and without additives Type: Acti-Fine® Vacuum Venous Blood Collection Tubes with Lithium Heparin, Gel		
	Version 2	Review date: 2022-01-17	Page 13

Note: * - size tolerances are shown in Drawing 1.

Vacuum tubes have single-layer wall 0.75 – 1.42 mm thick.

The mass of additives in a vacuum test tube must ensure the concentration of active substances in the taken blood in accordance with EN ISO 6710.

The concentration of lithium heparin salt should be between 12 and 30 international units (IU) of heparin per ml of blood.

Gel mass should be between 0.8 and 1.9 g per tube.

9. Tube supply package

Name	Quantity per package, pcs.
1. Acti-Fine® Vacuum Venous Blood Collection Tubes with Lithium Heparin, Gel	50/100

10. Safety requirements

When handling Vacuum tubes, observe safety rules, occupational sanitation, anti-epidemic regime and personal hygiene in laboratories (departments, divisions), according to the local regulation.

Precautions when handling Vacuum tubes – observe the instructions on prevention of infectious disease outbreak in clinical diagnostic laboratories of healthcare centers according to local regulation.

11. Requirements to environmental safety when handling medical product

During operation, transportation and storage the Vacuum tubes do not have a negative impact on people or environment, provided that the consumers observe the requirements stipulated in the User Manual.

12. Sterilization method

Radiation sterilization is electron beam sterilization at absorbed dose of 14.8 kGy. The sterilization process is validated as per EN ISO 11137-1.

13. Package

The Vacuum tubes are inserted into plastic foam holders – 50 or 100 pcs. per holder, and wrapped in polyethylene thermal film at least 15 µm thick. A label containing data according to pt. 14 Marking is attached to the package.

The transportation package of Vacuum venous blood collection tubes consists of boxes made as per GOST 13514 or GOST 9142 of corrugated cardboard complying with GOST R 52901. Vacuum tubes in plastic foam holders wrapped in polyethylene thermal film are

placed in the boxes – max. 2000 pcs. per box. The transportation box is wrapped in general purpose packing band (adhesive tape) on polymer or fabric base with a width of at least 45 mm. A label containing data according to pt. 14 Marking is attached to each transportation package.

Dimensions and weight of packages:

Gross weight of Vacuum tubes in primary package does not exceed 0.8 kg.

Gross weight of Vacuum tubes in transportation package does not exceed 17 kg.

Dimensions of primary package do not exceed 187 x 187 x 125 mm.

Dimensions of transportation package do not exceed 400 x 600 x 400 mm.

14. Marking

The green color on the labels of tubes with lithium heparin, gel is compliant with requirements of EN ISO 6710.

Marking of Vacuum tubes is printed on the label according to the requirements of EN ISO 6710 and EN ISO 15223-1.

Vacuum tubes labels do not enfold the Tubes completely. An allowed gap between the label edges is at least 3 mm.

Marking and labelling of Vacuum venous blood collection tubes stay attached to Vacuum venous blood collection tubes after exposure to open air at (4 ± 1) °C for at least 48 h.

Labels of Vacuum venous blood collection tubes contain the following data:

- name and/or trademark of the manufacturer;
- catalogue number of the Tube;
- batch number and/or an appropriate symbol according to EN ISO 15223-1;
- use-by date (year-month) and/or an appropriate symbol according to EN ISO 15223-1;
- description of contents including:
 - rated capacity;
 - name of additive or its formula, and/or letter code;
 - color code of the Tube;
- filling mark;
- “Sterile” inscription and/or an appropriate symbol according to EN ISO 15223-1, specifying the sterilization method;
- “For single use only” inscription and/or an appropriate symbol according to EN ISO 15223-1;
- “For in vitro diagnostics” inscription and/or an appropriate symbol according to EN ISO 15223-1;

– additional data (may be applied by agreement with the customer), which may include:

- full name;
- identifier;
- date of birth;
- date;
- time;
- signature;
- bar code – a unique code of the Tube;
- customer's data.

The outer side of each primary package contains the following information:

- name of product;
- name and/or trademark and address of the manufacturer;
- name of the authorized EU representative;
- batch number and/or an appropriate symbol according to EN ISO 15223-1;
- catalogue number;
- use-by (year-month) and/or an appropriate symbol according to EN ISO 15223-1;
- description of the contents including:
 - rated capacity;
 - name of additive or its formula, and/or letter code;
 - dimensions;
- “Sterile” inscription and/or an appropriate symbol according to EN ISO 15223-1, specifying the sterilisation method;
- “For single use only” inscription and/or an appropriate symbol according to EN ISO 15223-1;
- storage temperature requirements;
- “Caution! See Supporting Documents” caution;
- “For in vitro diagnostics” inscription and/or an appropriate symbol according to EN ISO 15223-1;
- number of products in the package;
- additional data (may be applied by agreement with the customer), customer data, bar-code.

Transportation marking is applied on the side wall of the transportation package and contains the following data:

- “Upwards” and “Keep dry” handling symbols;
- name of product;
- name and/or trademark and address of the manufacturer;

- batch number and/or an appropriate symbol according to EN ISO 15223-1;
- catalogue number;
- use-by date (year-month) and/or an appropriate symbol according to EN ISO 15223-1;
- description of the contents including:
 - rated capacity;
 - name of additive or its formula, and/or letter code;
 - dimensions;
- “Sterile” inscription and/or an appropriate symbol according to EN ISO 15223-1, specifying the sterilization method;
- “For single use only” inscription and/or an appropriate symbol according to EN ISO 15223-1;
- storage temperature requirements;
- “Caution! See Supporting Documents” caution;
- “For in vitro diagnostics” inscription and/or an appropriate symbol according to EN ISO 15223-1;
- number of products in the package;
- variant of product;
- additional data (may be applied by agreement with the customer), customer data, bar-code.

15. Transportation, storage and handling conditions

Transportation

Vacuum tubes are transported in covered vehicles by any means of transportation according to the shipping rules applicable to the corresponding means of transportation.

The following conditions must be observed at transportation of Vacuum tubes in covered vehicles: temperature from +2 to +35°C, relative humidity not exceeding 80% at +25°C.

Storage

Vacuum tubes must be stored indoors in coolers or refrigerators ensuring the required conditions: temperature from +4 to +25°C, relative humidity not exceeding 80% at +25°C – in primary package or in transportation package at a distance of at least 1 m from heaters and protected from sunlight and weather impact.

Warning!

If the storage temperature is higher than recommended, it may reduce the Tube quality (vacuum may be lost, liquid additives may dry out or dye, etc.).

Handling

Vacuum tubes must be handled according to the instructions set out in the operating documents.

Vacuum tubes must be handled at temperature from +18 to +35°C and relative humidity not exceeding 80% at +25°C.

Do not use Vacuum tubes after expiration of the best before date.

16. Technical maintenance and repair

The product does not require any technical maintenance and is not subject to repair.

17. Shelf life

Shelf life of Vacuum venous blood collection tubes with lithium heparin, gel is 18 months after sterilization.

18. Warranty

The manufacturing plant warranties conformance of the product to the requirements, if handling, transportation and storage conditions are met.

Guaranteed shelf life of Vacuum venous blood collection tubes with lithium heparin, gel is 18 months after sterilization.

19. Disposal or destruction of medical product

Vacuum tubes are disposed of according to the local rules and regulations on sanitary and epidemiological requirements for medical waste disposal.

After use, Vacuum tubes are classified as hazardous waste in respect of outbreak of blood transmitted infectious diseases.

Used Vacuum tubes must be disinfected by autoclaving at temperature 121°C and pressure 1.2 atm. in standard polyethylene disposal bags.

Unused Vacuum tubes are classified as epidemiologically safe medical waste with contents close to solid domestic waste.

20. List of regulatory documents

EN ISO 18113-1:2011 In vitro diagnostic medical devices – Information supplied by the manufacturer (labelling) – Part 1: Terms, definitions and general requirements

EN ISO 15223-1:2016 Medical devices – Symbols to be used with medical device labels, labelling and information to be supplied – Part 1: General requirements

EN ISO 6710:2017 Single-use containers for human venous blood specimen collection

EN 556-1:2001 + AC:2006 Sterilization of medical devices – Requirements for medical devices to be designated "STERILE" – Part 1: Requirements for terminally sterilized medical devices

EN ISO 11137-1:2015 Sterilization of health care products – Radiation – Part 1: Requirements for development, validation and routine control of a sterilization process for medical devices

21. Claims

On issues relating the medical product quality please contact Granat Bio Tech LLC at: 10 Akademika Kadyshevskogo Street, Dubna, Moscow Region, Russia, 141980.



In vitro Medical Device User Manual.
Acti-Fine® Vacuum Venous Blood Collection Tubes with and
without additives
Type:
Acti-Fine® Vacuum Venous Blood Collection Tubes with
Lithium Heparin, Gel

Version 2

Review date: 2022-01-17

Page 18

Tel.: +7(495) 103-41-16, info@granatbio.ru.

